



cura della persona assistenza socio sanitaria

Overview



Metodologia: ciclo degli interventi



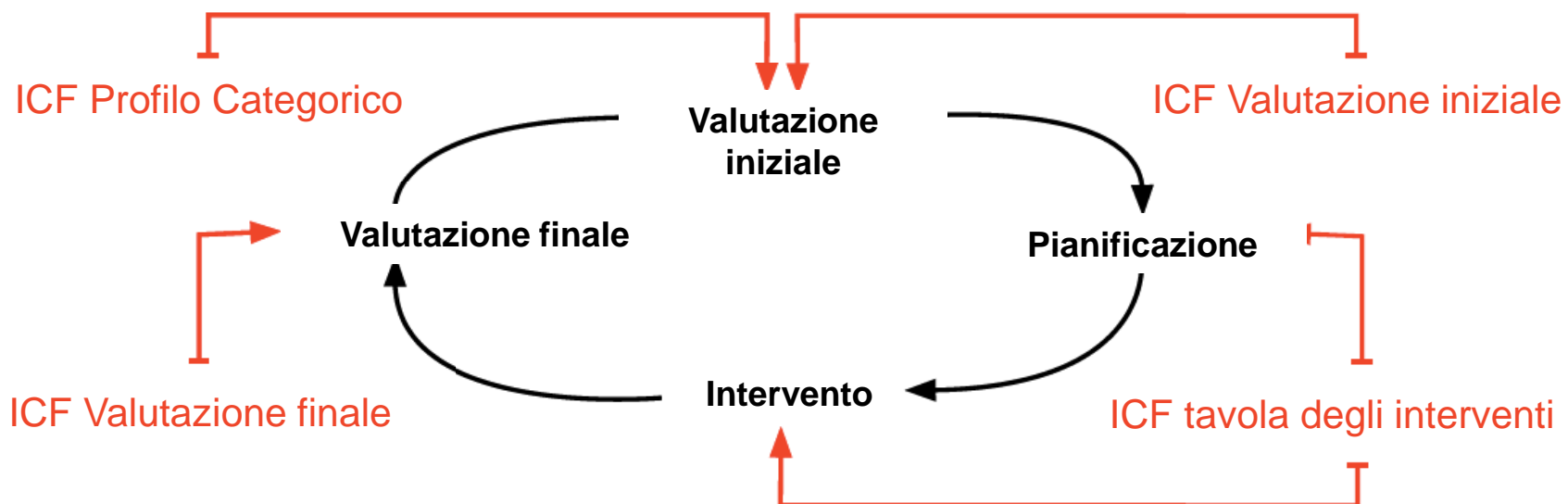

- assessment mediante **ICF**
- gestione scale di valutazione
- gestione degli **interventi**
- Valutazione di raggiungimento degli **obiettivi**
- **tool di supporto** per team meeting interni e UMVD
- **dashboard**

Navigazione grafica

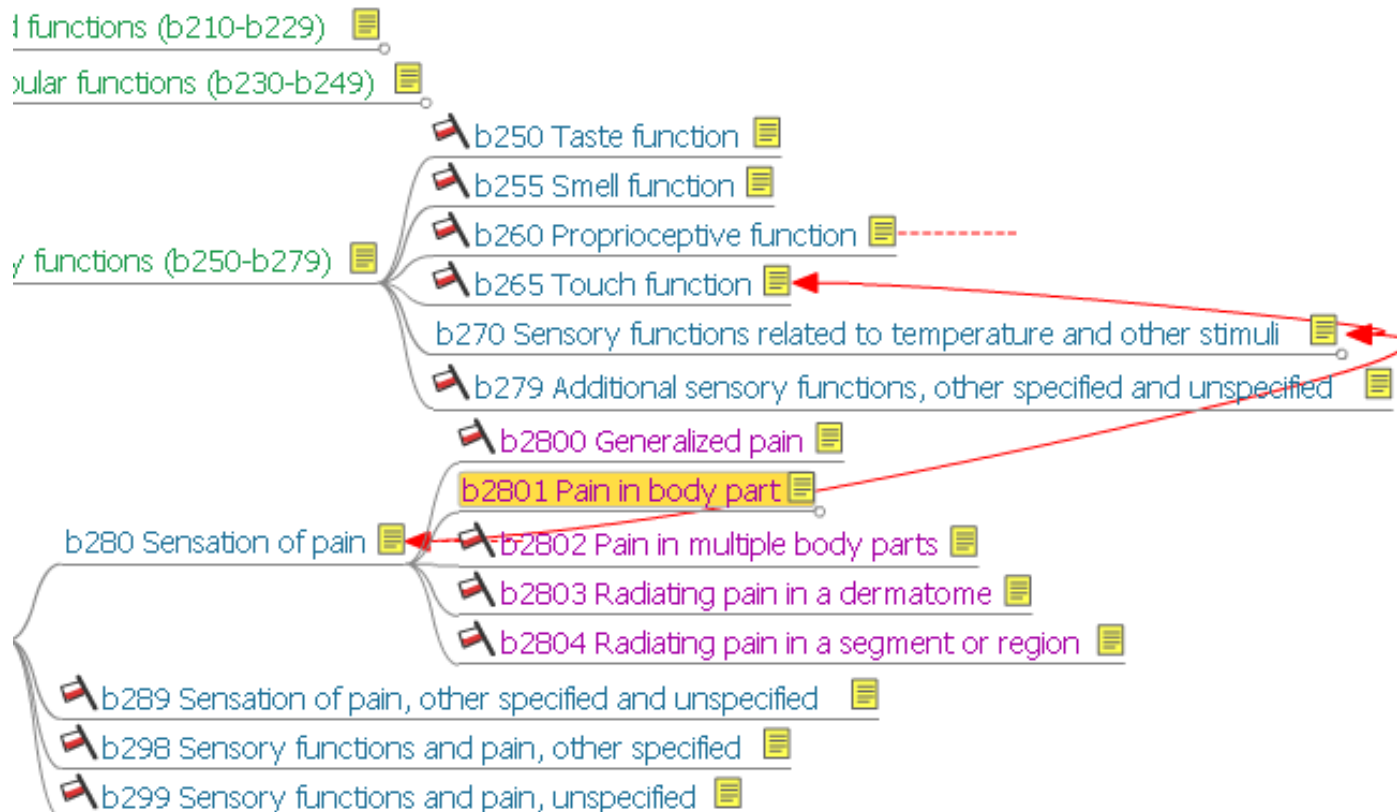

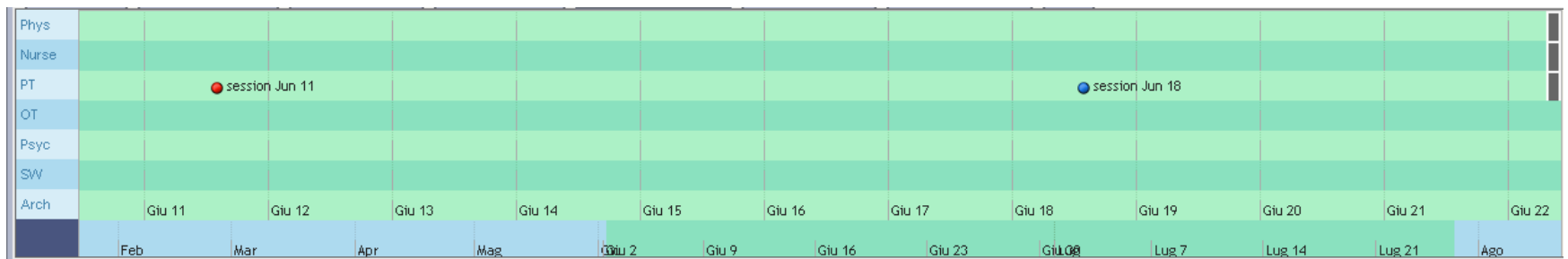

La pianificazione

Scale di valutazione





Tavola degli interventi

KRehab Assignment		Cs2: Michael Perry - snowboard accident - 12 weeks post-trauma									
		utente: usrkoine oggi: 24/2/2015 versione: 1.Alpha17									
Rehab Cycle Assessment Sheet Categorical Profile Intervention Table Intervention Sessions Evaluation Display Acknowledgements map		save map print reports index									
ICF code	Intervention target	Intervention	Phys	Nurse	PT	OT	Phych	SW	Arch	FV	GV
b260	Proprioceptive functions									3	1
b28013	Pain in the back	Body posture training			Y		Y			3	0
b28013	Pain in the back	Adaptation of wheelchair				Y				3	0
b28013	Pain in the back	Control of sitting position		Y	Y	Y				3	0
b28013	Pain in the back	Medication	Y							3	0
b415	Blood vessel functions at risk	Compression hosery and drugs	Y	Y						0	0
b420	Blood pressure function	Compression hosery	Y	Y						1	0
b7101	Mobility of several joints	Passive movement note here	Y	Y	Y	Y	Y	Y	Y	1	0
b755	Involuntary movement functions	Body balance training			Y					2	0
b7800	Sensation of muscle stiffness	Detonisation and Stretching			Y					1	0
b810	Structure of the skin - at risk	Daily inspection		Y						0	0
d410	Changing basic body positions	Sit up-training			Y					1	0
d4153	Maintaining a sitting position	Body balance training			Y					1	0
d4200	Transferring oneself while sitting	Transfer training			Y	Y				2	1
d465	Moving around with wheelchair	Wheelchair training outdoor			Y					3	1
d510	Washing oneself	Assistance/Instruction		Y						2	0
d520	Caring for body parts	Assistance/Instruction		Y						2	0
d5300	Regulating urination	Assistance/Instruction		Y						2	0
d5301	Regulating defecation	Assistance/Instruction		Y						2	0
d540	Dressing	Assistance/Instruction		Y						2	0
d9201	Sport	Exercising different sports		Y		Y				4	2
e1151	Assistive products: Chair cushion	Control of chair cushion			Y					2	0
e1201	Assistive products for personal mobility: Wheelchair and adapted car	Testing of different wheel-chairs and reconstruction of car				Y				3	0
e155	Design construction and building products and technology of buildings for private use: farm house	Planning and reconstruction of private building				Y				3	2
pf	Knowledge	Teaching and consulting and lectures	Y	Y	Y	Y	Y	Y		-	+
pf	Acceptance/Coping of disease	Behavioral training approaches		Y	Y	Y	Y	Y		-	=

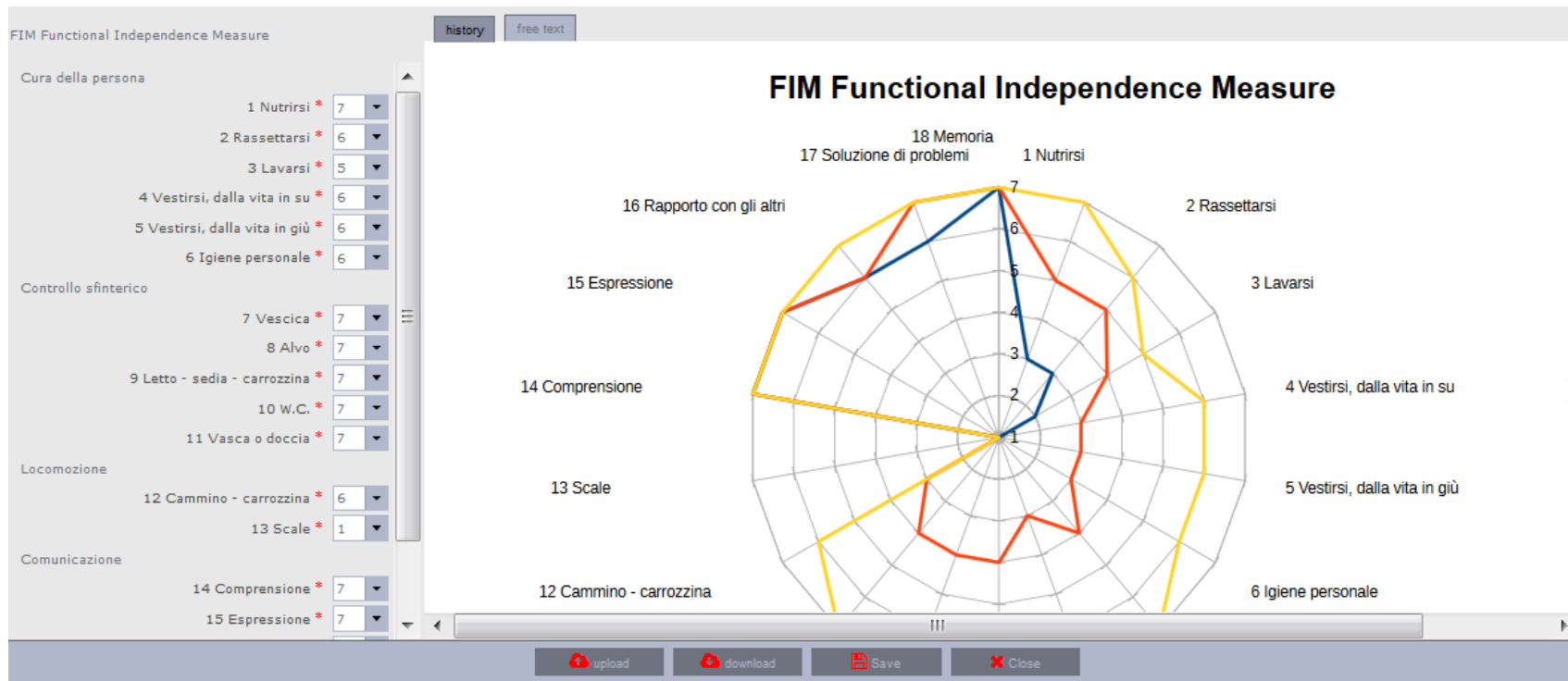
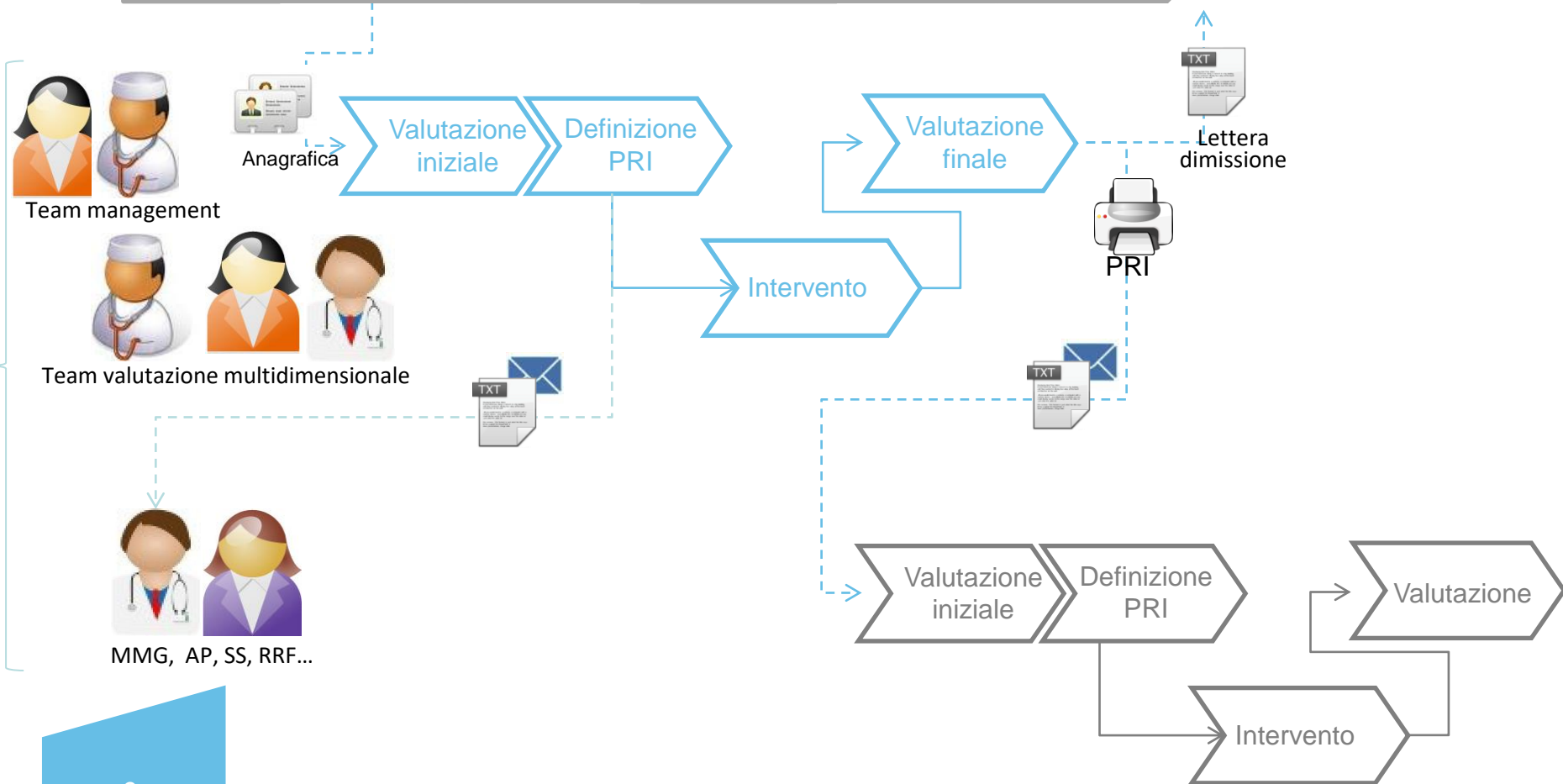

Processi gestiti



KRehab Evaluation

Cs2: Michael Perry - snowboard accident - 12 weeks post-trauma

utente ▼ usrkoinè
 oggi: 24/2/2015
 versione: 1.Alpha17

Rehab Cycle
Assessment Sheet
Categorical Profile
Intervention Table
Intervention Sessions
Evaluation Display
Acknowledgements
map

Evaluation (16 week post-trauma)

-	GOALS	-	-	GV	EV	-	GA
GG	Complete independence, university entrance	<div style="width: 20px; height: 10px; background-color: orange;"></div>		0	0	<div style="width: 20px; height: 10px; background-color: #ccc;"></div>	+
SPG	Independence in activities of daily living	<div style="width: 20px; height: 10px; background-color: orange;"></div>		0	0	<div style="width: 20px; height: 10px; background-color: #ccc;"></div>	+
CG1	Mobility	<div style="width: 20px; height: 10px; background-color: orange;"></div>		1	1	<div style="width: 20px; height: 10px; background-color: #ccc;"></div>	+
CG2	Self-care	<div style="width: 20px; height: 10px; background-color: orange;"></div>		0	0	<div style="width: 20px; height: 10px; background-color: #ccc;"></div>	+
CG3	Sport	<div style="width: 20px; height: 10px; background-color: orange;"></div>		2	1	<div style="width: 20px; height: 10px; background-color: #ccc;"></div>	+

facilitators / barriers area

ICF	Categories	4+3+2+1+ 0 1 2 3 4	Goal rel	GV	EV	4+3+2+1+ 0 1 2 3 4	GA
e1151	Assistive products: Chair cushion	<div style="width: 20px; height: 10px; background-color: orange;"></div>	CG1	0	0	<div style="width: 20px; height: 10px; background-color: #ccc;"></div>	+
e1201	Assistive products for personal mobility: Wheelchair and adapted car	<div style="width: 20px; height: 10px; background-color: orange;"></div>	CG1	0	2+	<div style="width: 20px; height: 10px; background-color: #ccc;"></div>	+
e155	Design construction and building products and technology of buildings for private use: farm house	<div style="width: 20px; height: 10px; background-color: orange;"></div>	SPG	2	2+	<div style="width: 20px; height: 10px; background-color: #ccc;"></div>	+
e5700	Social security services	<div style="width: 20px; height: 10px; background-color: orange;"></div>	SPG,GG	4+	2+	<div style="width: 20px; height: 10px; background-color: #ccc;"></div>	-

personal factors area

ICF	Categories	Posit Neutr Negat	Goal rel	GV	EV	Posit Neutr Negat	GA
pf	Knowledge	<div style="width: 20px; height: 10px; background-color: orange;"></div>	SPG	+	+	<div style="width: 20px; height: 10px; background-color: #ccc;"></div>	+
pf	Acceptance/Coping of disease	<div style="width: 20px; height: 10px; background-color: orange;"></div>	GG	=	-	<div style="width: 20px; height: 10px; background-color: #ccc;"></div>	-

problems area

save
map
print
reports index

ICF	Categories	problem 0 1 2 3 4	Goal rel	GV	EV	problem 0 1 2 3 4	GA
b260	Proprioceptive functions	<div style="width: 20px; height: 10px; background-color: orange;"></div>		1	0	<div style="width: 20px; height: 10px; background-color: #ccc;"></div>	+
b28013	Pain in the back	<div style="width: 20px; height: 10px; background-color: orange;"></div>	CG1	0	1	<div style="width: 20px; height: 10px; background-color: #ccc;"></div>	-
b415	Blood vessel functions at risk	<div style="width: 20px; height: 10px; background-color: orange;"></div>	GG	0	0	<div style="width: 20px; height: 10px; background-color: #ccc;"></div>	+
b420	Blood pressure function	<div style="width: 20px; height: 10px; background-color: orange;"></div>	CG1	0	1	<div style="width: 20px; height: 10px; background-color: #ccc;"></div>	-
b7101	Mobility of several joints	<div style="width: 20px; height: 10px; background-color: orange;"></div>	CG1,C G2	0	1	<div style="width: 20px; height: 10px; background-color: #ccc;"></div>	-
b755	Involuntary movement funtions	<div style="width: 20px; height: 10px; background-color: orange;"></div>	CG1,C G2	0	0	<div style="width: 20px; height: 10px; background-color: #ccc;"></div>	+
b7800	Sensation of muscle stiffness	<div style="width: 20px; height: 10px; background-color: orange;"></div>	CG1,C G2	0	0	<div style="width: 20px; height: 10px; background-color: #ccc;"></div>	+
b810	Structure of the skin - at risk	<div style="width: 20px; height: 10px; background-color: orange;"></div>	GG	0	0	<div style="width: 20px; height: 10px; background-color: #ccc;"></div>	+
d410	Changing basic body positions	<div style="width: 20px; height: 10px; background-color: orange;"></div>	CG1	0	0	<div style="width: 20px; height: 10px; background-color: #ccc;"></div>	+
d4153	Maintaining a sitting position	<div style="width: 20px; height: 10px; background-color: orange;"></div>	CG1,C G2	0	0	<div style="width: 20px; height: 10px; background-color: #ccc;"></div>	+
d4200	Transferring oneself while sitting	<div style="width: 20px; height: 10px; background-color: orange;"></div>	CG1	1	1	<div style="width: 20px; height: 10px; background-color: #ccc;"></div>	+
d465	Moving around with wheelchair	<div style="width: 20px; height: 10px; background-color: orange;"></div>	CG1	1	2	<div style="width: 20px; height: 10px; background-color: #ccc;"></div>	-
d510	Washing oneself	<div style="width: 20px; height: 10px; background-color: orange;"></div>	CG2	0	0	<div style="width: 20px; height: 10px; background-color: #ccc;"></div>	+
d520	Caring for body parts	<div style="width: 20px; height: 10px; background-color: orange;"></div>	CG2	0	1	<div style="width: 20px; height: 10px; background-color: #ccc;"></div>	-
d5300	Regulating urination	<div style="width: 20px; height: 10px; background-color: orange;"></div>	CG2	0	0	<div style="width: 20px; height: 10px; background-color: #ccc;"></div>	+
d5301	Regulating defecation	<div style="width: 20px; height: 10px; background-color: orange;"></div>	CG2	0	0	<div style="width: 20px; height: 10px; background-color: #ccc;"></div>	+
d540	Dressing	<div style="width: 20px; height: 10px; background-color: orange;"></div>	CG2	0	0	<div style="width: 20px; height: 10px; background-color: #ccc;"></div>	+
d9201	Sport	<div style="width: 20px; height: 10px; background-color: orange;"></div>	CG3	2	2	<div style="width: 20px; height: 10px; background-color: #ccc;"></div>	+

Schema generale

KICF-SS: gestione cicli intervento alla persona con ausilio di APP - Chat Bot - Wearable

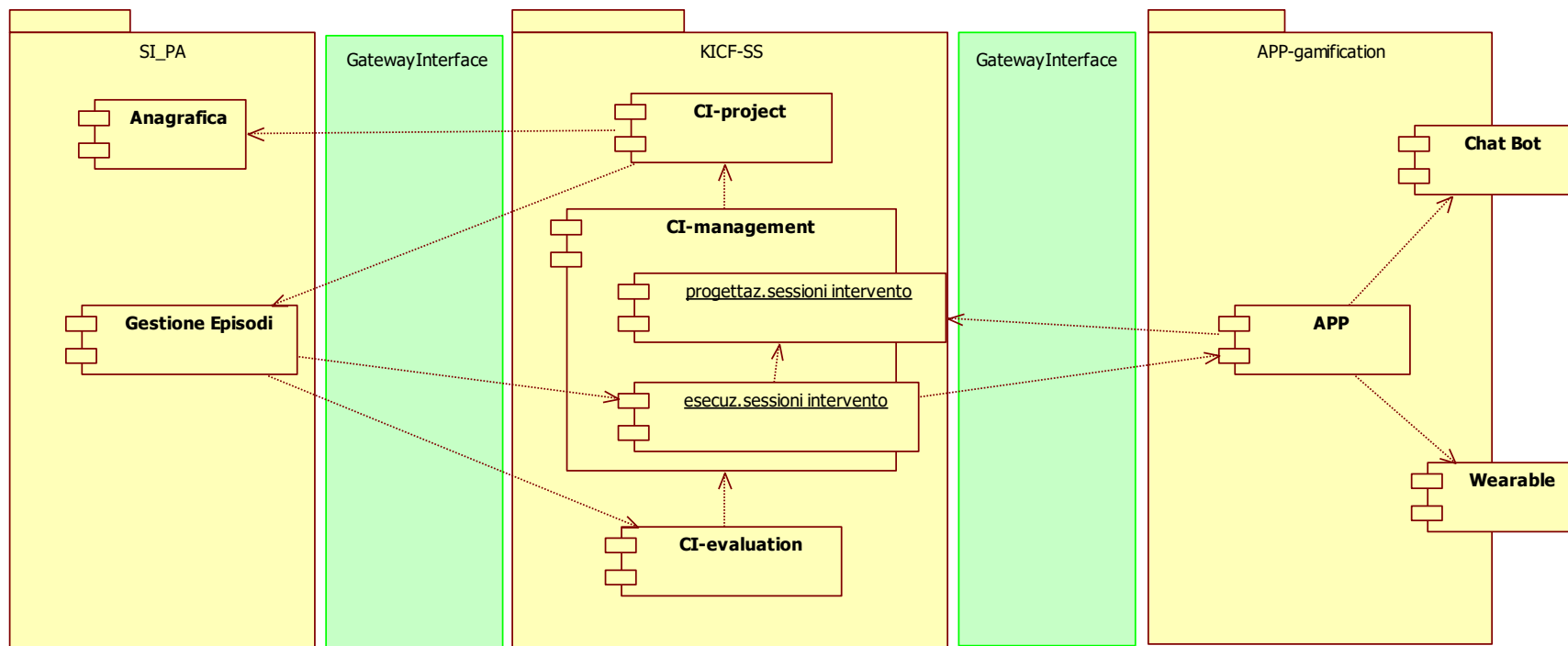



® Dati, di fatto.

Fine



KOINÈ SISTEMI

Corso Regina Margherita, 153
10122 Torino